







ASSEMBLY INSTRUCTION MIND07

S No.	Name of Component		Qty.
Ⓐ	Carcass / Body 		1
①	Legs 		4
②	Bolts 		16
③	Spanner 		1
④	Bracket 		2
⑤	Tie 		1
⑥	Screw Ø4 X 20 		4

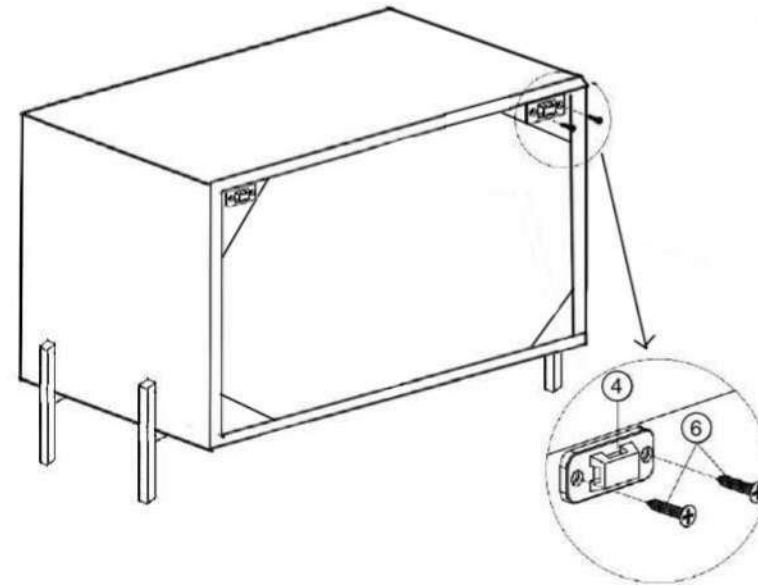

STEP 5

BACK VIEW

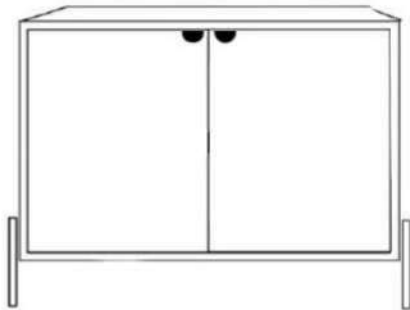



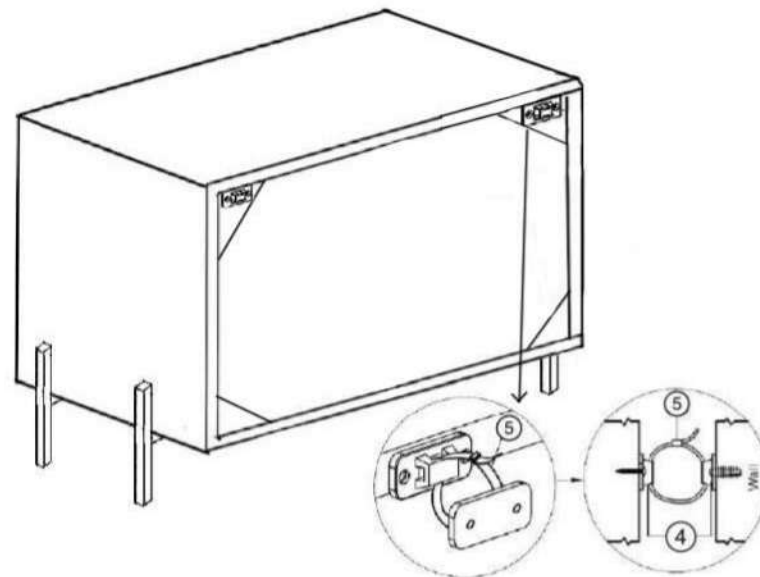



FINAL PRODUCT (FRONT VIEW)



FINAL

BACK VIEW

ASSEMBLY INSTRUCTION MIND07

S No.	Name of Component	Qty.
Ⓐ	Carcass / Body 	1
①	Legs 	4
②	Bolts 	16
③	Spanner 	1
④	Bracket 	2
⑤	Tie 	1
⑥	Screw Ø4 X 20 	4

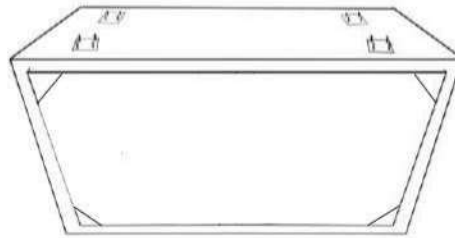

Ⓐ

STEP 1

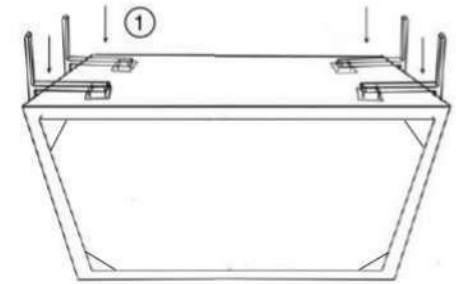

STEP 2

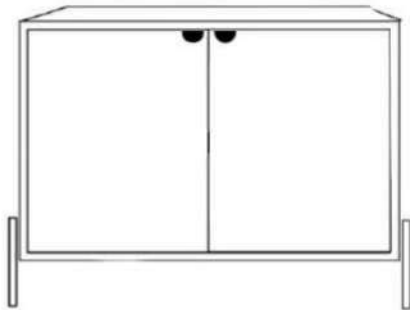

FINAL PRODUCT (FRONT VIEW)

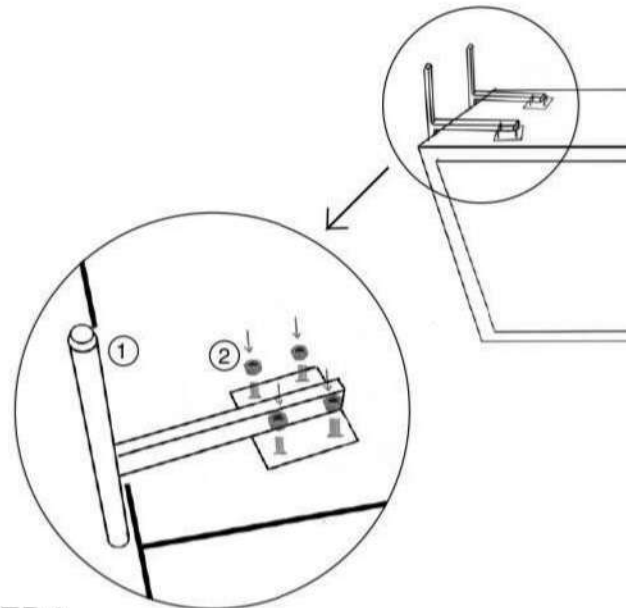

STEP 3

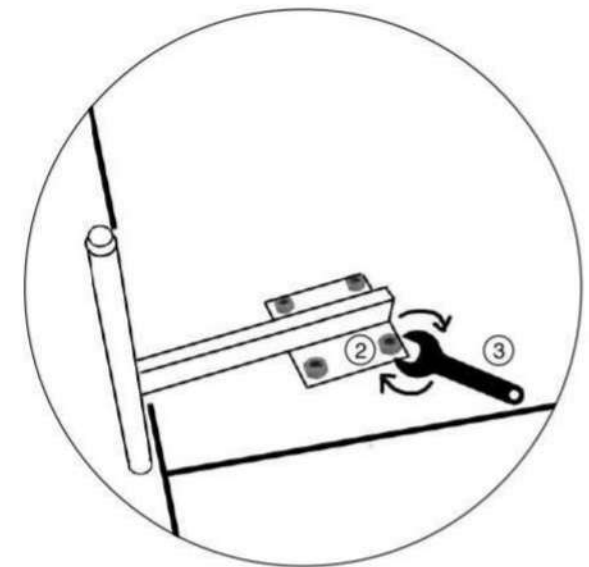

STEP 4