





# ASSEMBLY INSTRUCTIONS

## Part List

Label	Picture	Description	Qty.
1.		TOP	1 Pc.
2.		LEG	2 Pcs.

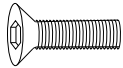
## HARDWARE LIST :

Label	Picture	Description	Qty.
A		ALLEN BOLT 8 x 16 mm	16 Pcs.
B		WASHER 25 mm	16 Pcs.
C		ALLEN KEY 5 mm	1 Pcs.

## STEP-1

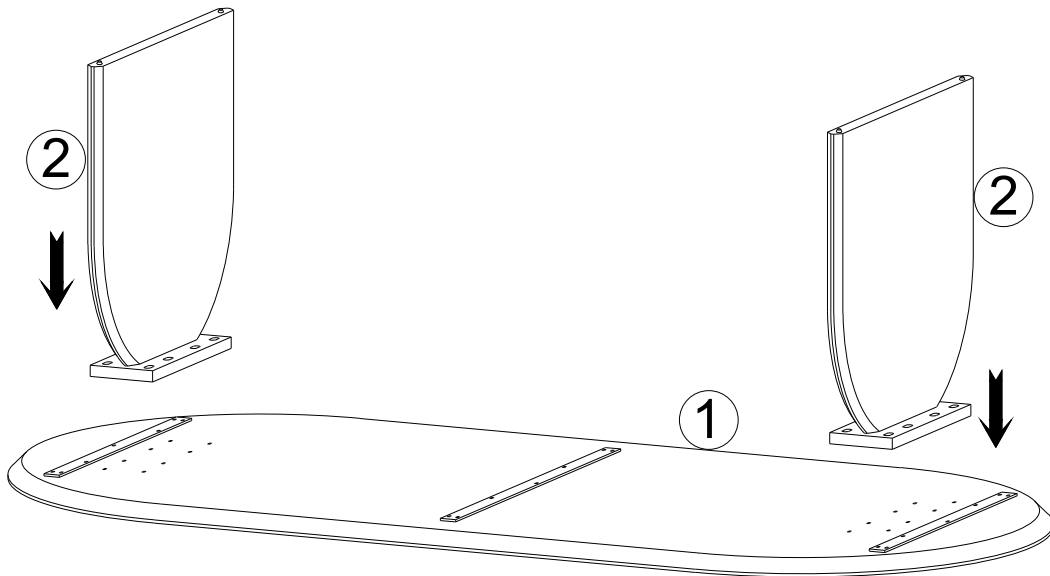

## STEP-2

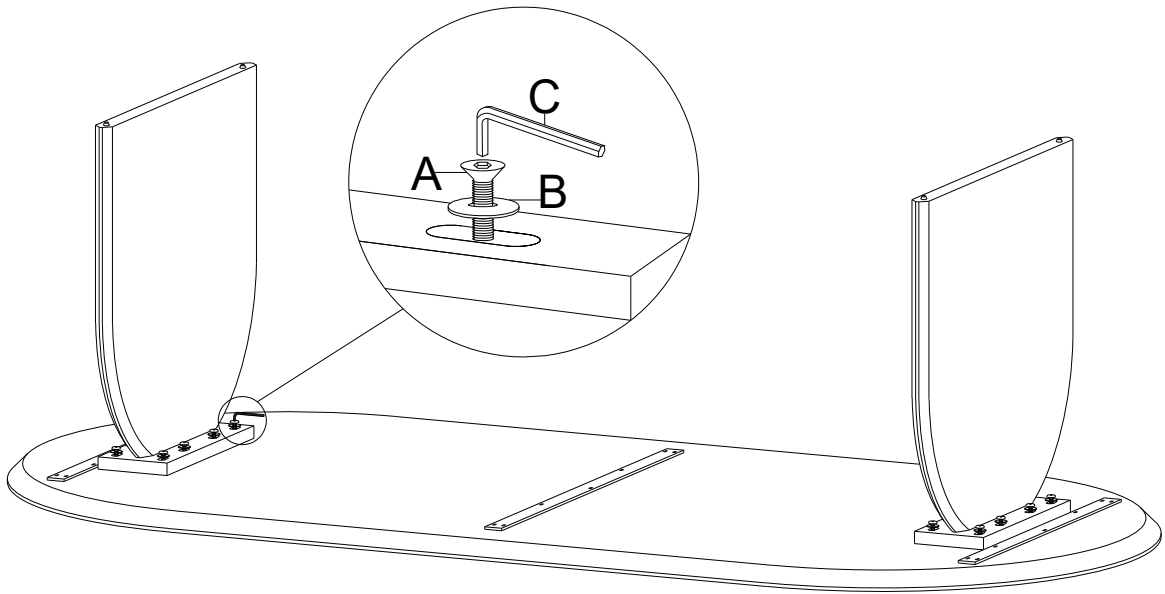

## STEP-3

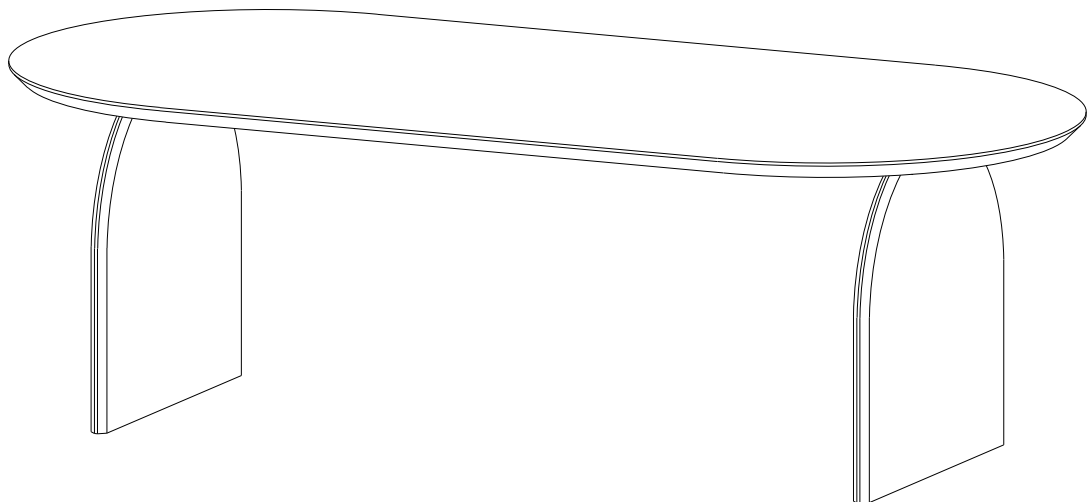

COMPLETELY ASSEMBLED